

MASTER TECHNICIANS  
SERVICE CONFERENCE

REFERENCE BOOK  
**'72-1**

# THE '72 THERMO-QUAD CARBURETOR

PLYMOUTH • DODGE • CHRYSLER • IMPERIAL • DODGE TRUCK



**CHRYSLER**  
MOTORS CORPORATION

[www.carburetor-manual.com](http://www.carburetor-manual.com)

## IT'S EASY WHEN YOU KNOW THE BASICS...

Remember the first carburetor you took apart? Maybe you worried about getting all those parts back where they belonged, or the adjustments had you confused. But then, with an understanding of basic systems plus a look at the Service Manual, the next job went easier and it all became routine.

It's still that way with new model carburetors, even for some experienced technicians. But it's not like starting over at the beginning, in spite of changes in carburetor appearance and added refinements, because underneath it all the same basic systems are still there.

Following Tech's advice, we're going to assume that the basics of four-barrel carburetor operation are generally understood as we cover the Thermo-Quad carburetor used on some of our '72 models. For orientation, the differences from earlier, more familiar carburetors are described first, followed by the adjustments and some helpful servicing hints.

### TABLE OF CONTENTS

THERMO-QUAD FEATURES.....	1
Choke Diaphragm Operation .....	2
Accelerator Pump Operation .....	4
Step-Up Piston and Metering Rods.....	5
THERMO-QUAD ADJUSTMENTS .....	6
Secondary Throttle Link .....	6
Air Valve Spring Tension .....	7
Air Valve Opening .....	7
Accelerator Pump Stroke.....	7
Choke Control Lever.....	8
Diaphragm Connector Rod .....	8
Vacuum Kick .....	9
Fast-Idle Cam and Linkage .....	10
Choke Unloader .....	10
Secondary Throttle Pick-Up Lever .....	11
Fast-Idle Speed .....	11
Curb-Idle Speed .....	11
Bowl Vent Valve .....	12
Float Height Setting .....	12
THERMO-QUAD SERVICING HINTS.....	13

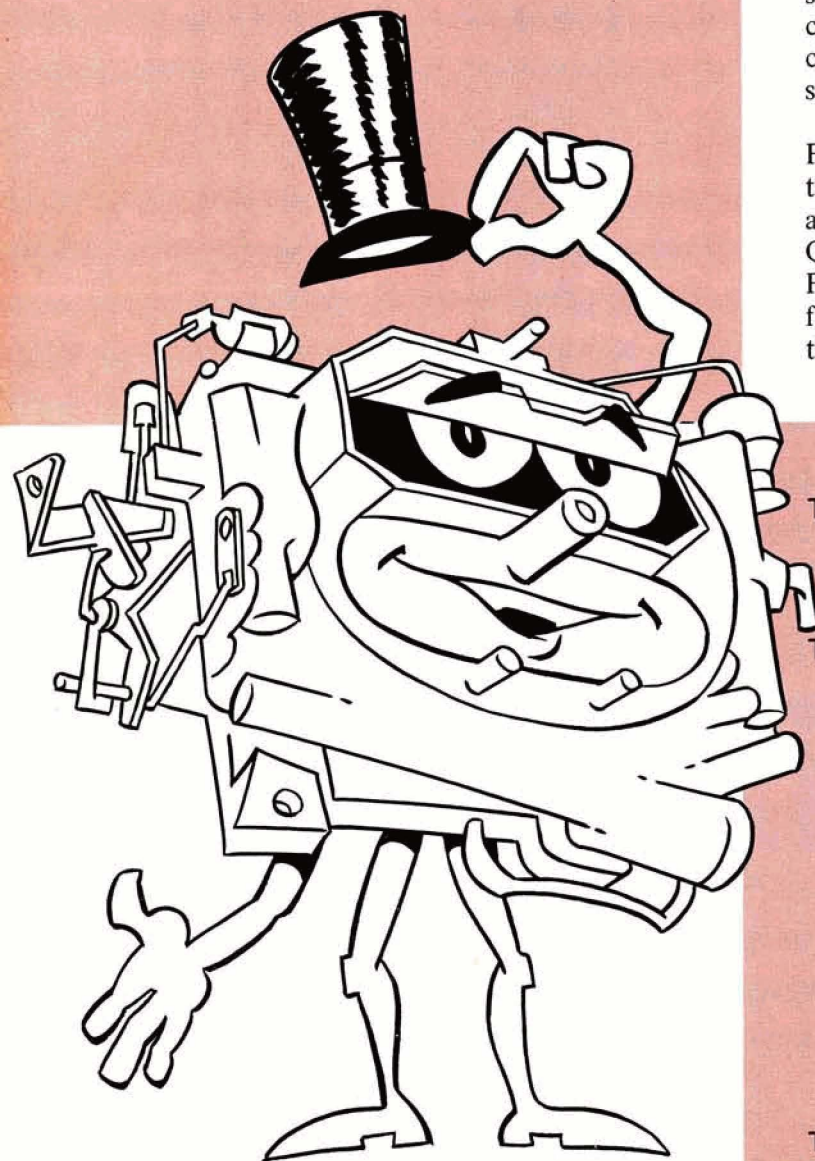



## THERMO-QUAD FEATURES

As suggested by the name, the unique feature of the Thermo-Quad carburetor is its lower operating temperature, which results mainly from the insulating properties of the molded plastic fuel bowl and the "suspended" design of the fuel metering system. Tests show that the Thermo-Quad runs as much as 20° cooler than all-metal carburetors.

### FUEL BOWL CUTS HEAT CONDUCTION

The plastic fuel bowl reduces engine heat conduction both to the fuel in the bowl and to the metering system built into the bowl cover. The metering system parts extend down into the fuel bowl and, except for the linkage and bowl cover screws, there is essentially no metal-to-metal contact to transfer heat from the engine manifold to the fuel in the bowl or to the bowl cover metering parts.

### LESS HEAT IMPROVES PERFORMANCE

Important advantages are gained by holding carburetor and fuel temperatures down. For example, there is less chance of flooding due to overheated fuel expansion when the engine is shut off, especially in hot weather. And, a cooler-running carburetor maintains a more constant air-fuel mixture ratio in all operating ranges.

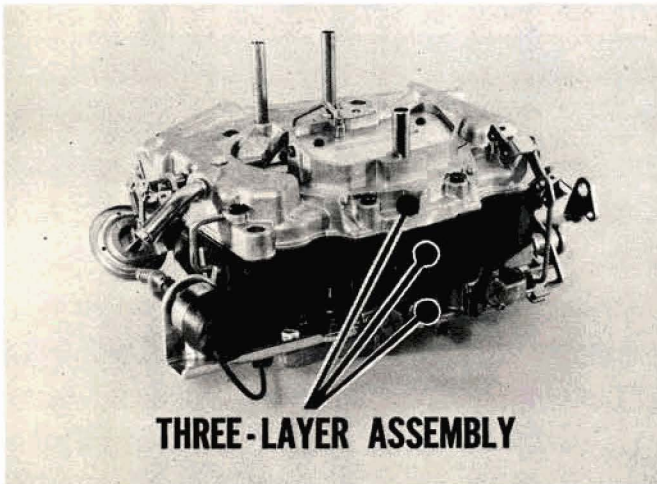

**THREE-LAYER ASSEMBLY**

*Fig. 1—Bowl acts as heat barrier*

### DESIGN LOWERS EXHAUST EMISSIONS

Thermo-Quad metering calibration is leaner because mixture enrichment is not needed to compensate for fuel expansion power losses. As a result, exhaust emissions are reduced without seriously affecting engine performance.

### AIR MIXES IN AT DISCHARGE

The '72 Thermo-Quad has a conventional, venturi-throated primary section, and straight-bore, air-valve-type secondaries. In operation, the metering system feeds the primary and secondary discharge nozzles with a solid, continuous stream of fuel which mixes with air *after* it leaves the nozzles. This differs from '71 Thermo-Quads and other carburetors with conventional air-bleed metering systems which introduce the air into the fuel stream *before* discharge from the nozzles.

### PRIMARY METERING HAS MANUAL CONTROL

Primary fuel flow is controlled by two metering rods yoked to a single, vacuum-operated step-up piston which reacts basically to engine loading. During the primary operation phase, the step-up piston and the metering rods are raised mechanically by a cam and lever arrangement which will be described farther on.

### CHOKE DISCONNECTS SECONDARIES

The secondary throttle valves are mechanically linked to the primaries and begin to open at approximately 70 m.p.h. During the choking phase, a pickup lever disengages to keep the secondary throttle valves from opening. When the choke opens and the fast-idle linkage moves to off position, the pickup lever drops into position where it engages the secondary throttle linkage to open the throttle valves.

### SECONDARY METERING IS CONVENTIONAL

Secondary fuel flow is metered by conventional jets connected to discharge nozzles which begin delivery when the secondary throttle valves start to



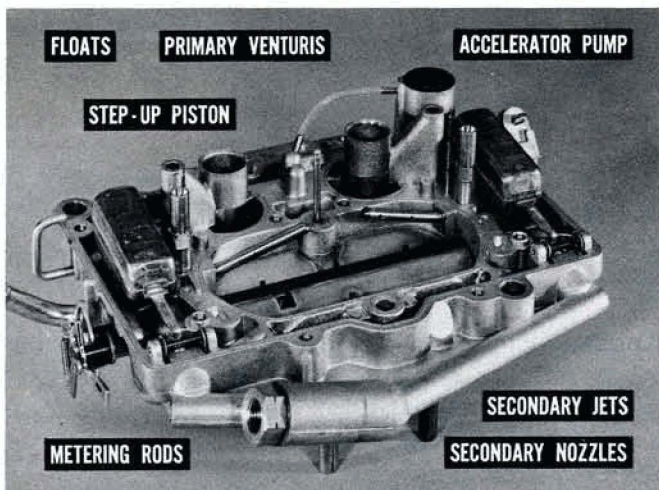

Fig. 2—Cover includes metering components

open. As already mentioned, the fuel discharges in a solid stream which mixes with air after leaving the nozzles.

### BOWL COVER CARRIES METERING PARTS

Float and needle valve assemblies, primary discharge nozzles and venturis, accelerator pump and jet, step-up piston and metering rods, and the secondary jets and nozzles are all part of the bowl cover assembly. Two primary metering jets and a baffle plate are the only parts located in the plastic fuel bowl.

### VALVES ARE LINKED TO DIAPHRAGM

The bowl cover also houses a conventional choke valve and a spring-loaded secondary air valve. However, unlike similar carburetors, both valves in the

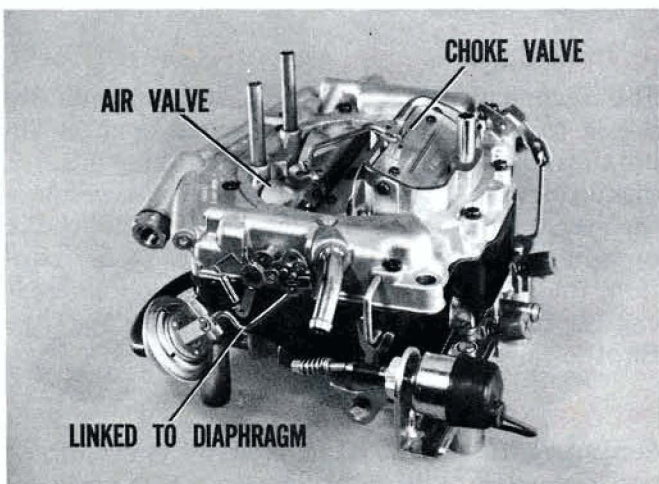

Fig. 3—Both valves are linked to diaphragm

Thermo-Quad carburetor are linked to the choke vacuum-kick diaphragm.

### CHOKES DIAPHRAGM DOES DUAL DUTY

In this case, the choke diaphragm does two jobs. Besides its regular vacuum-kick function, the diaphragm also restrains the air valve to keep it from opening too quickly. If the air valve opens before adequate flow begins at the secondary nozzles, flat spots can result.

### SEPARATE SETTINGS NEEDED

Because the choke diaphragm has two distinct functions, separate adjustments must be made to set the air valve control and the vacuum kick. Since these adjustments are inter-related, they must be made in the sequence described in this book and the Service Manuals.

### THROTTLE BODY HOUSES CAM AND LEVER

The throttle body section forms the mounting flange of the carburetor and houses the primary and secondary throttle valves. The step-up piston cam and lever are also located in the throttle body.

### SOLENOID DETERMINES IDLE SPEED

A curb-idle speed solenoid is mounted on the carburetor throttle body casting or on the intake manifold on the throttle lever side. This solenoid maintains a relatively high idle speed when the engine is running, but retracts when the ignition is turned off so the throttle can close farther to prevent "after-running".

### Choke Diaphragm Operation



Fig. 4—No secondary operation when choke is on

As in other carburetors, engine vacuum moves the choke diaphragm inward to produce vacuum-kick action. However, the Thermo-Quad diaphragm stem is linked directly to the secondary air valve shaft lever by a connecting rod which also picks up the choke adjusting lever. This pickup action produces the vacuum-kick opening of the choke valve.

### SECONDARIES STAY CLOSED

While the engine is warming up with the choke on, a tang on the fast-idle operating lever lifts the secondary throttle pickup lever and disengages the secondary throttle linkage. This prevents the secondary throttle valves from opening when the choke is on, even if the pedal is floored.



Fig. 5—Lever picks up secondary linkage

### PICKUP LEVER ENGAGES LINKAGE

The secondary throttle pickup lever drops and engages the throttle linkage when the fast-idle linkage moves to its off position. The secondary throttle valves can then open in a normal manner, but as long as these valves are closed, the choke diaphragm holds the secondary air valve closed.

### PASSAGE IS OPEN TO MANIFOLD

Vacuum is routed to the choke diaphragm through a passage which connects to a chamber in the bottom of the throttle body. This chamber is open to manifold vacuum regardless of throttle position.

### VACUUM BLEED PASSAGE ALSO USED

In addition, a bleed passage extends from the diaphragm vacuum passage to a small port in the secondary bore on the choke diaphragm side of the carburetor. This port is closed by the secondary

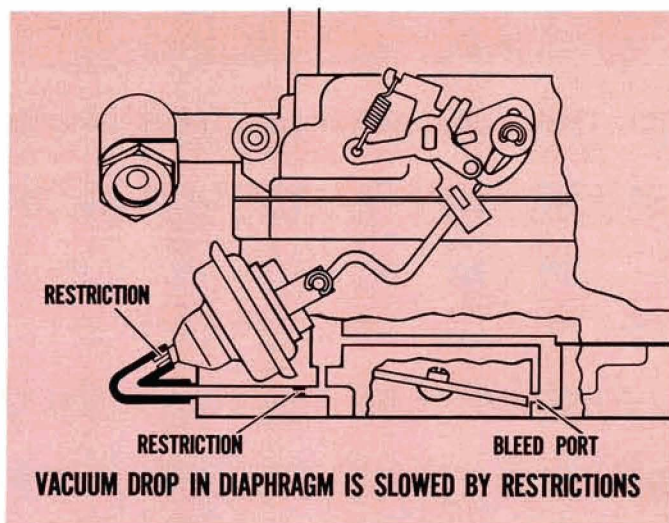

Fig. 6—Restrictions slow vacuum bleed-off

throttle valve and does not affect diaphragm vacuum as long as the valve is closed.

### DIAPHRAGM VACUUM DROPS SLOWLY

When the secondary throttle valves open, manifold vacuum drops abruptly but the drop in the diaphragm is slowed by restrictions at the bleed port and in the vacuum passage to the diaphragm.

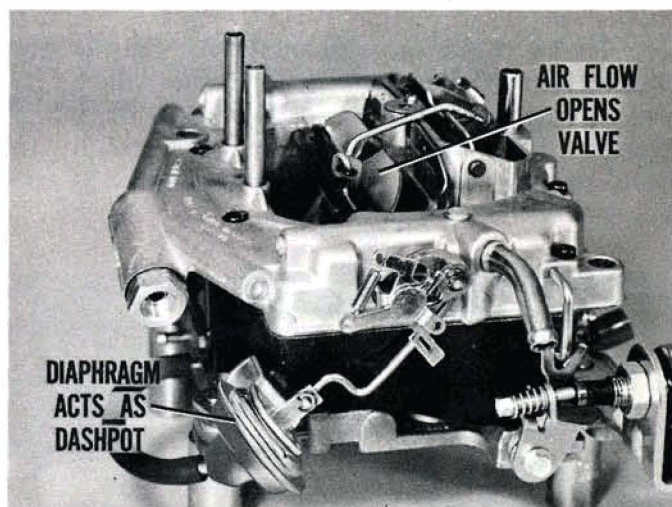

Fig. 7—Diaphragm slows air valve opening

### DASHPOT ACTION CONTROLS VALVE

As the vacuum bleeds off, the choke diaphragm acts as a dashpot, preventing the secondary air valve from opening too quickly. As a result, incoming air flow opens the air valve at a rate which provides smooth pickup of the secondary discharge nozzle operation.

## Accelerator Pump Operation

The Thermo-Quad accelerator pump cylinder is part of the bowl cover casting and connects to its discharge jet in the primary section through a short flexible tube. The intake check valve assembly acts as a bottom closure for the pump cylinder.

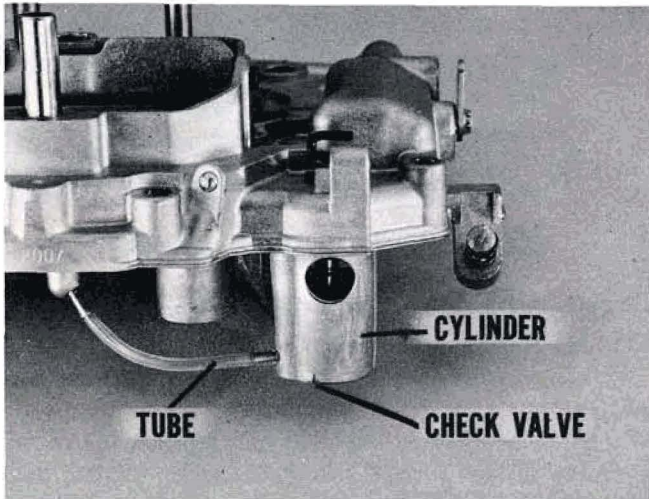

Fig. 8—Accelerator pump is built into cover

## PLUNGER SHAFT REMOVES VALVE

The intake check valve assembly fits tightly into the bottom of the pump cylinder and can be removed by tapping lightly on the end of the pump plunger shaft. Tap the plunger end carefully to guard against damage to the shaft guide lugs cast into the bowl cover.

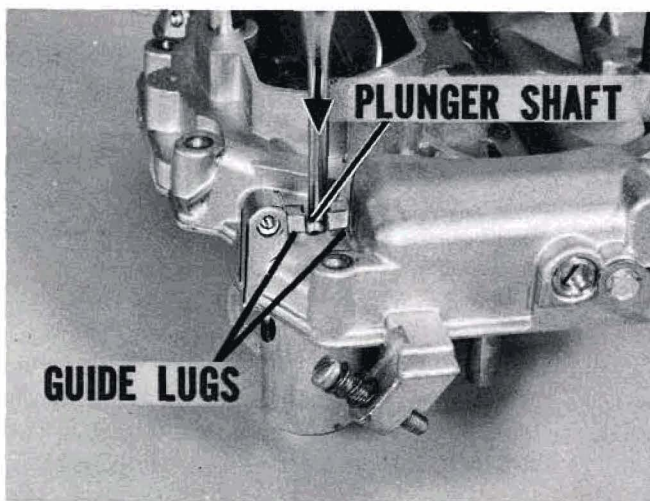

Fig. 9—Tap shaft end to remove check valve

## PUMP LINK CONTROLS TRAVEL

Because less pump output is needed at higher speeds in TorqueFlite-equipped models, the pump plunger "S" link angles outward at its center so the link can move over-center. This arrangement reduces plunger travel when the throttle is in the higher speed range.

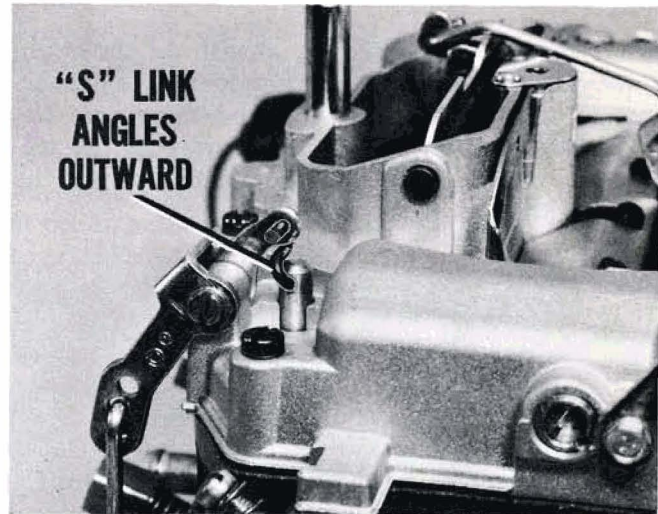

Fig. 10—Over-center action cuts plunger travel

## SOME MODELS NEED MORE OUTPUT

Full pump output must be available longer for smooth acceleration of manual transmission models, so a two-stage linkage with a pump stroke pickup lever is used. This model requires two separate accelerator pump adjustments, which must be made in sequence.

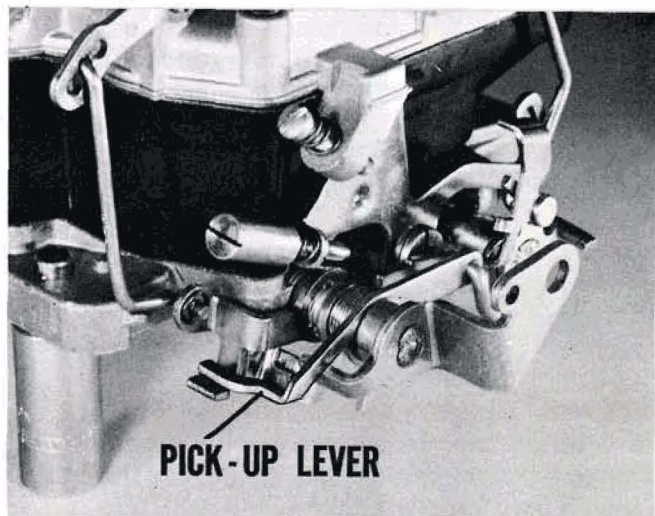

Fig. 11—Staged pump for manual-shift models

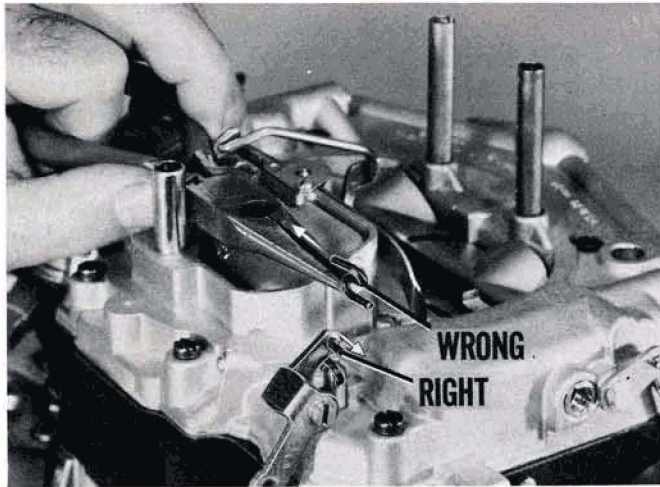

Fig. 12—Wrong link position can cause hangup

### INSTALL "S" LINK PROPERLY

Because the accelerator pump plunger link is angled for over-center operation, there is a wrong way and a correct way to install it. The link will go on either way, but can hang up over-center if the top part of the "S" points inward instead of out. The correct installation is shown in an accompanying illustration.

### Step-Up Piston and Metering Rods

In the Thermo-Quad primary metering section, the two metering rods are yoked to a single step-up piston which rides in a cylinder in the bowl cover casting. As mentioned earlier, the primary jets which work with the metering rods are located in the plastic fuel bowl.

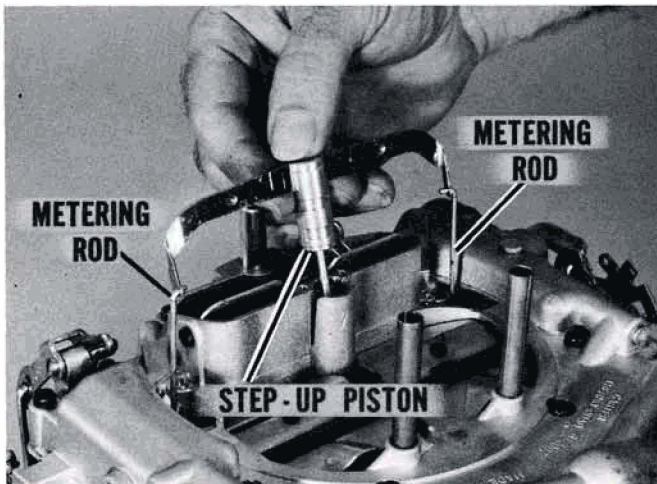

Fig. 13—Single piston operates metering rods

### CAM AND LEVER RAISE LIFT ROD

For its mechanical operation, the step-up piston has a lift rod which extends down through a passage in the fuel bowl into the throttle body. The bottom end of the rod rides on a lever operated by a cam on the primary throttle shaft.

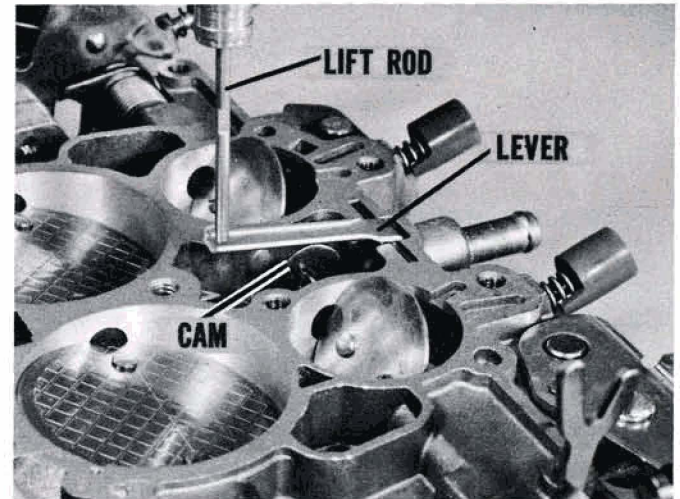

Fig. 14—Lift rod extends down through bowl

### LIFTING ACTION FOLLOWS THROTTLE

In the low- and medium-speed range, the cam and lever lift the step-up piston and metering rods in proportion to the primary throttle valve opening. This action provides positive mixture control regardless of variations in engine vacuum.

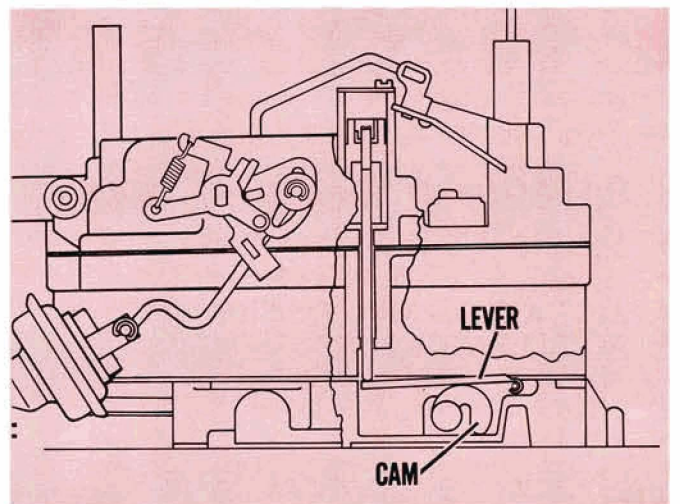

Fig. 15—Cam provides positive mixture control

### VACUUM BALANCES SPRING FORCE

As the secondary throttle valves open, the step-up

piston operates the metering rods in the conventional manner. Vacuum on the piston balances against spring force to position the metering rods and vary the mixture as required by changes in operating conditions.

### TAMPERING IS A NO-NO

The length of the step-up piston lift rod is factory-adjusted on equipment not available in service. Tampering with the setting will upset performance and emission control, so it should not be disturbed.

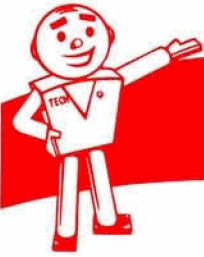

## THERMO-QUAD ADJUSTMENTS

Before you touch any carburetor adjustment, first check out all other possible trouble sources. Then, if linkage adjustments are needed, make them in the proper sequence so one adjustment does not undo preceding ones.

Nearly all Thermo-Quad adjustments can be made on or off the engine. However, the carburetor must be removed to check or adjust the secondary throttle link. Fast-idle speed, curb-idle speed, and bowl vent valve settings are adjusted with the carburetor installed.

To cover the Thermo-Quad adjustments, we'll describe each external setting in the order recommended for a complete checkout. Adjustments which can be made separately are indicated. In general, adjustments which require bending must be made in sequence.

### THERMO-QUAD ADJUSTMENT SEQUENCE

- SECONDARY THROTTLE LINK
- SECONDARY AIR VALVE OPENING
- AIR VALVE SPRING TENSION
- ACCELERATOR PUMP STROKE
- CHOKE CONTROL LEVER
- CHOKE DIAPHRAGM ROD
- VACUUM KICK
- FAST-IDLING CAM & LINKAGE
- CHOKE UNLOADER
- SECONDARY THROTTLE PICKUP LEVER
- FAST-IDLING SPEED
- CURB-IDLING SPEED
- BOWL VENT VALVE

### Secondary Throttle Link

To check the secondary throttle link setting, the choke valve must first be blocked open. This lowers the outer tang on the fast-idle operating lever so the secondary throttle pickup lever moves into position to open the valves.

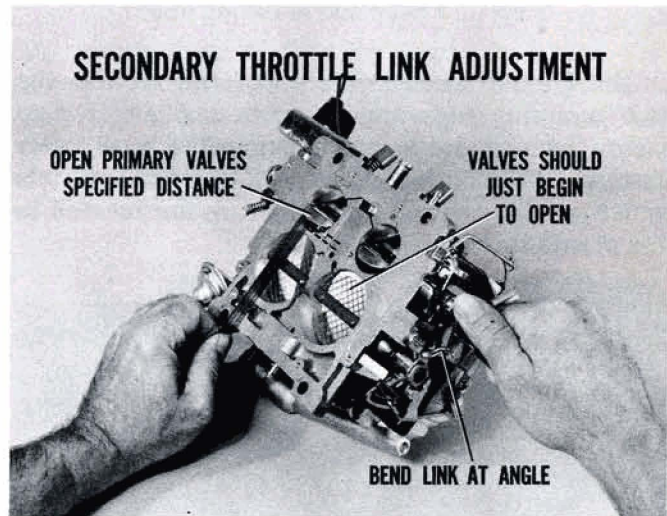

Fig. 16—Measure primary valve opening

Slowly open the primary throttle valves the specified distance from the throttle bore walls. At this point, the secondary throttle valves should just begin to open. To adjust the setting, bend the throttle link carefully at the angle. Be sure to support the link while bending so the connecting levers will not be distorted.





## Air Valve Opening

The secondary air valve opening adjustment comes next in the sequence, but can be made separately. First make sure that the air valve is aligned when closed, with the valve edges parallel with the inner walls of the valve opening in the fuel bowl cover.

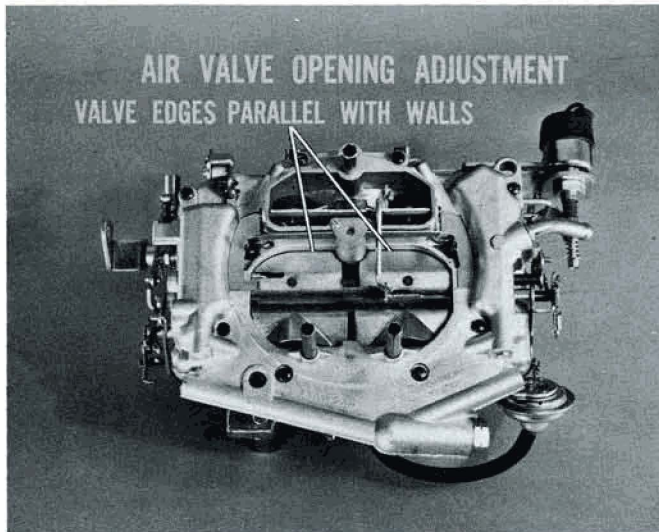

Fig. 17—Valve must be aligned in opening

Next, open the air valve against its stop and check for the specified gap between the valve edge and the outer wall of the primary air horn section. Bend the notched corner section of the air valve to adjust the opening if needed.

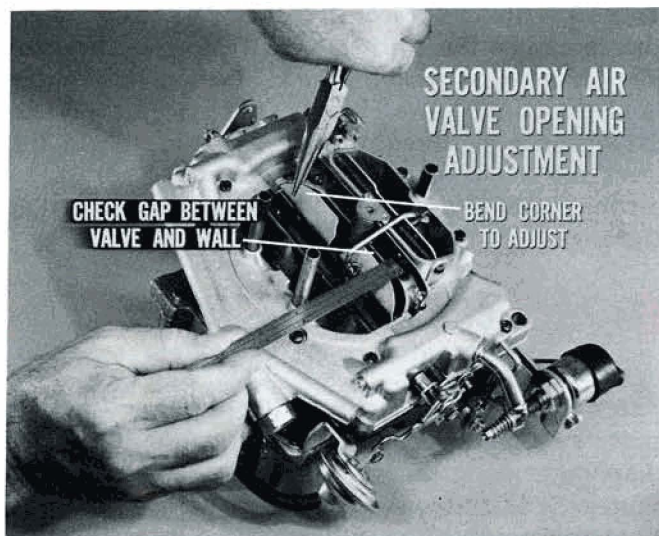

Fig. 18—Hold valve against stop to check opening

## Air Valve Spring Tension

The secondary air valve spring tension adjustment follows the valve opening adjustment, and can also be made separately. To begin, you first loosen the hollow spring-adjuster lock plug with the special C-4152 tool. This releases the spring windup tension and allows the air valve to drop open.

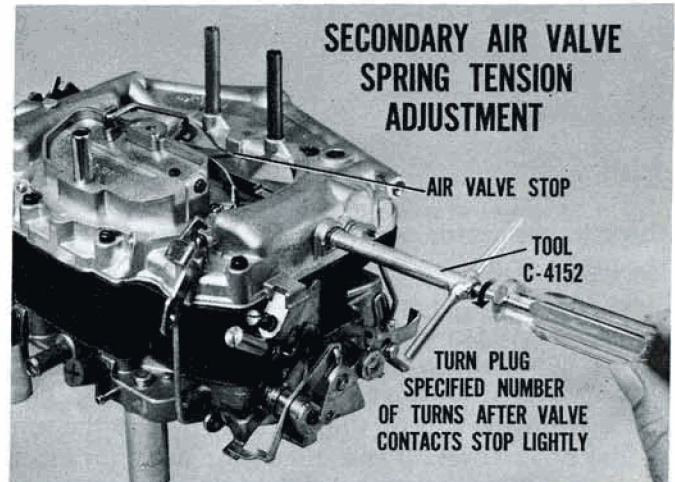

Fig. 19—Tighten lock plug to hold spring setting

### THE TOOL IS HOLLOW

Insert a screwdriver blade through the special tool and bring the air valve back up with initial spring windup tension until the valve lip contacts its closing stop lightly. To do this, you turn the adjustment plug counterclockwise gradually as you test for light closing contact by applying repeated opening pressure on the air valve.

### WIND UP THE SPRING

From the initial air valve closing position, continue to turn the adjusting plug the specified number of turns in the windup position. At this point, tighten the hollow lock plug with the special tool to hold the adjustment secure.

## Accelerator Pump Stroke

The basic accelerator pump stroke adjustment procedure is the same on all Thermo-Quads. Begin with the choke valve wide open and the fast-idle cam in the off position. Then turn out the throttle stop screw so the throttle valves can close completely. Also make sure that the hooked end of the

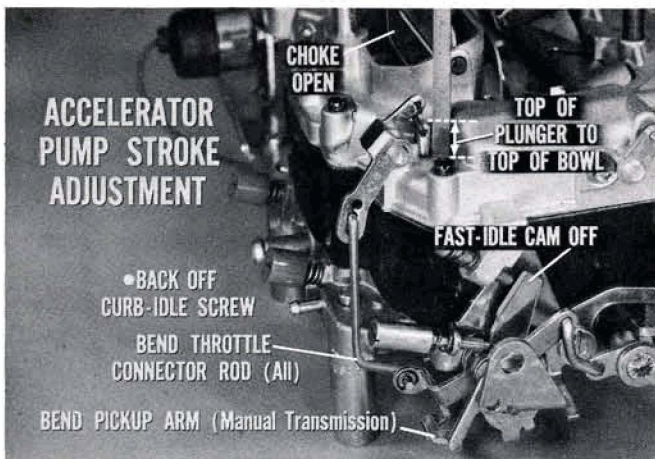

Fig. 20—Check setting with throttle valves closed

throttle connector rod is in the specified hole in the pump arm.

### CLOSE THROTTLE VALVES COMPLETELY

Apply light force on the throttle lever to hold the primary throttle valves closed. Measure the distance from the top of the plunger shaft to the top of the bowl cover. If this dimension does not meet the specifications, bend the throttle connector rod at the angle to correct.

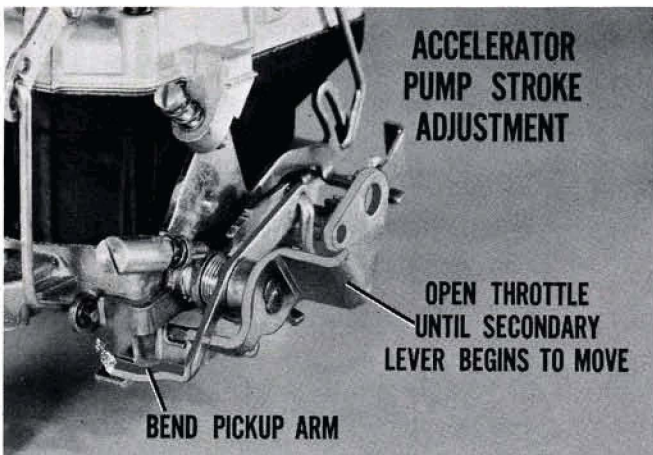

Fig. 21—Pickup arm on manual-shift models only

### MANUAL SHIFT ADDS A STEP

On manual transmission carburetors, you continue beyond the basic pump stroke setting by opening the throttle slowly until the secondary throttle shaft begins to move. Hold this position and again measure the stroke as before. If adjustment is needed, bend the pickup arm on the primary throttle shaft dog.

## Choke Control Lever

To check the choke control lever setting with the carburetor on the engine, you first remove the stainless-steel choke well from the manifold so you can use the top surface of the well opening as a reference point for the measurement.

### ESTABLISH A REFERENCE POINT

When checking with the carburetor off the engine, you set the carburetor base down on a flat surface which extends the base or flange line out under the choke control lever. This provides the lower reference point for the measurement.

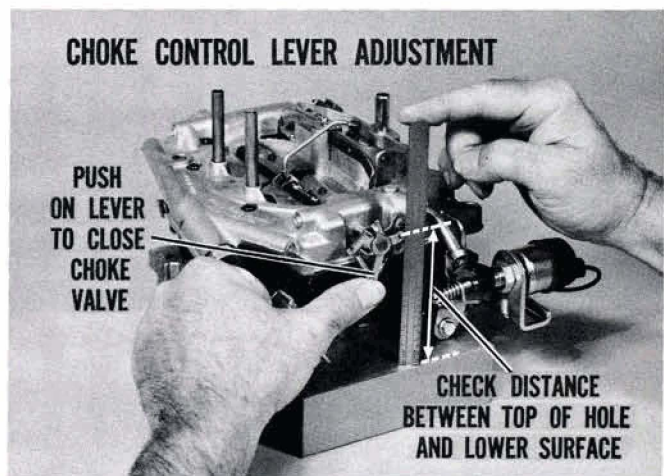

Fig. 22—Hold measuring scale vertical

### MEASURE VERTICAL DISTANCE

To check the choke control lever setting on or off the car, open the throttle slightly to free the fast-idle linkage and push on the choke control lever to hold the choke valve closed. Then check the vertical distance between the top of the hole in the lever and the lower reference surface. To adjust the setting, carefully bend the choke connecting rod at the angle.

## Diaphragm Connector Rod

After checking the choke control lever setting, we move on to the choke diaphragm. For the choke diaphragm connector rod adjustment and the vacuum-kick adjustment which follows, the choke diaphragm stem must be fully retracted by engine vacuum or by vacuum from an external source.

## ROD DOES NOT SET VACUUM KICK

Unlike other carburetors, the Thermo-Quad choke diaphragm connector rod adjustment determines the secondary air valve closing gap instead of setting the vacuum kick. You begin the connector rod check with the diaphragm stem retracted and the air valve in closed position.

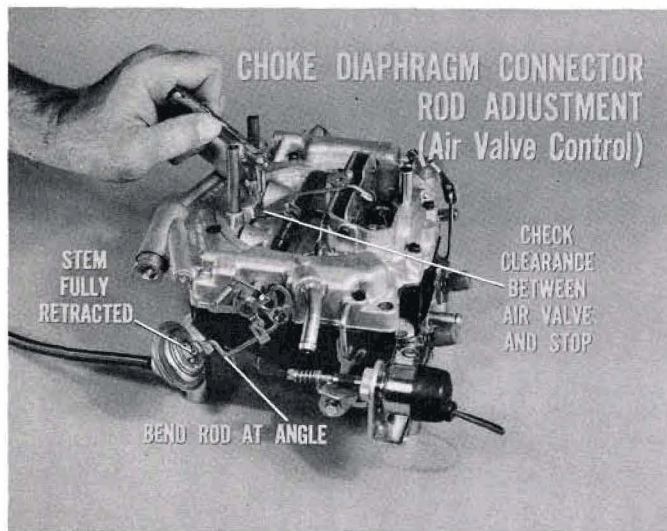

Fig. 23—Rod length determines valve position

## STOP IS IN CASTING

Check for the specified clearance between the secondary air valve lip and its closing stop on the bowl cover casting. If adjustment is needed, bend the choke diaphragm connector rod at the angle.

### Vacuum Kick

If you check the vacuum kick with the carburetor off the engine, first open the throttle so you can move the choke and fast-idle linkage to the closed position. Then release the throttle to trap the fast-idle cam in closed position. The choke diaphragm stem, of course, must be fully retracted.

## ON-ENGINE ADJUSTMENT

The same preliminary procedure can be used on the engine if you use an external vacuum source. However, when engine vacuum is used, you back off the fast-idle speed screw until the choke can be closed to the kick position at curb idle with the idle speed solenoid core fully extended. Note the number of turns backed off so you can restore the setting afterward.

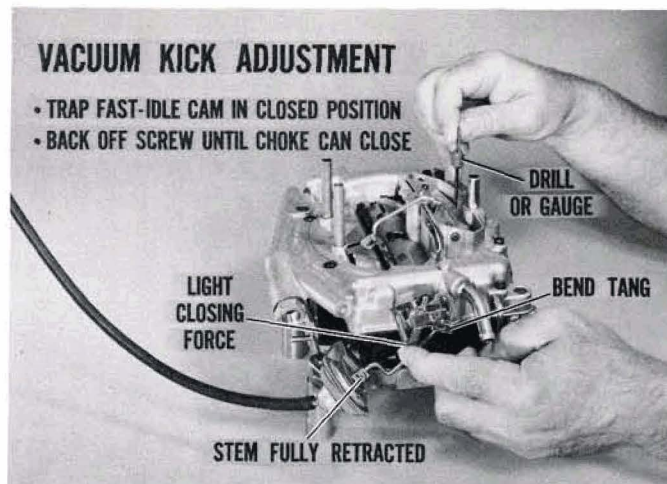

Fig. 24—Modulating spring must be extended

## EXTEND MODULATING SPRING

With the choke diaphragm stem retracted, apply light closing force on the choke control lever to extend the modulating spring and move the choke valve to the kick position. Use a specified drill or gauge to measure the kick opening.



Fig. 25—Tang position determines kick opening

## ADJUST FOR SLIGHT DRAG

You should be able to feel a slight drag when the drill or gauge is removed. To open or close the kick setting, bend the tang on the choke adjusting lever.

## PREVENT LEVER DISTORTION

The choke adjusting lever must be supported while the tang is bent or the choke control lever adjustment may be disturbed. For support, insert a screwdriver blade end in the “U”-shaped opening

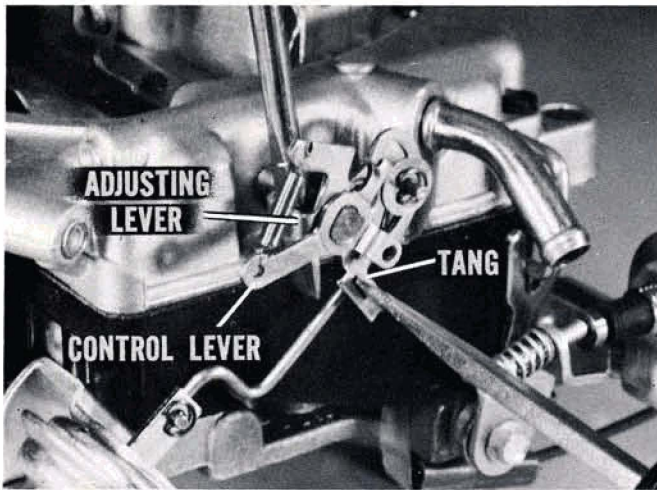

Fig. 26—Support lever when bending tang

between the adjusting lever and the choke counter-shaft which passes through it.

### Fast-Idle Cam and Linkage

The next step in the Thermo-Quad adjustment sequence is the fast-idle cam and linkage setting. To begin this adjustment, you first position the fast-idle operating lever by putting the fast-idle speed adjusting screw on the second step and against the shoulder of the first step of the cam.

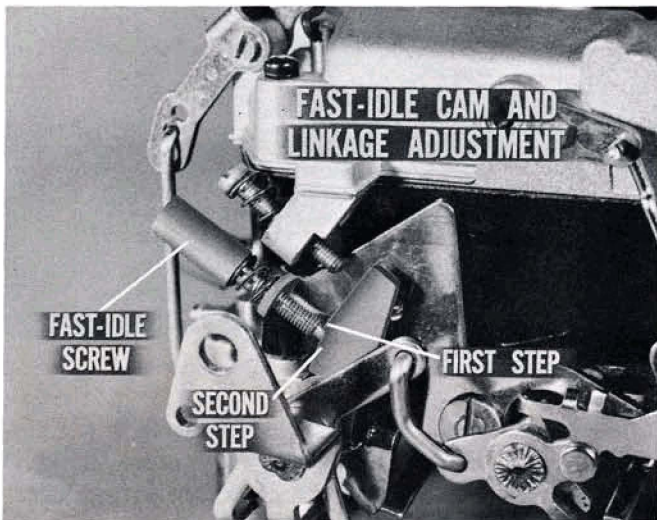

Fig. 27—Position cam before adjustment

### CLOSE VALVE FOR MEASUREMENT

With light closing force on the choke control lever, the choke valve must open the specified amount,

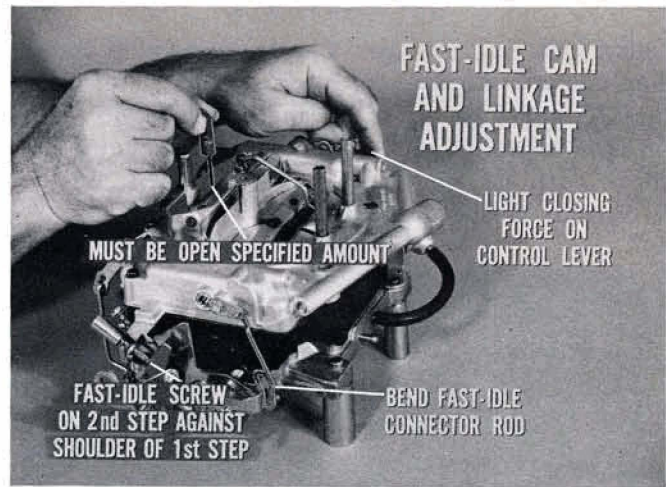

Fig. 28—Gauge should withdraw with slight drag

measured between the lower edge of the choke valve and the air horn wall. To adjust the valve opening, you bend the fast-idle connector rod at the angle.

### Choke Unloader

After the fast-idle cam and linkage setting, the choke unloader adjustment is next. Since the unloader operation permits maximum inlet air flow through the carburetor to overcome flooding, we check the setting with the throttle in the wide-open position.

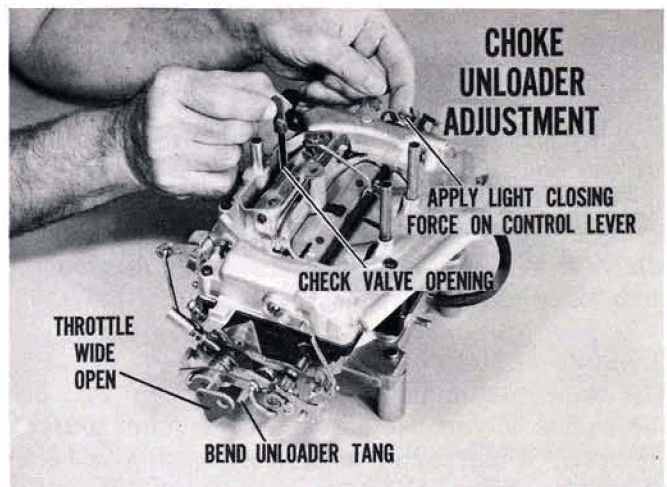

Fig. 29—Throttle must be wide open

### CLOSING FORCE ELIMINATES ERROR

Here again we apply light closing force on the

choke control lever and measure the amount that the choke valve opens. A light drag as the drill or gauge is removed is okay. Bend the unloader tang on the fast-idle operating lever to adjust.

### Secondary Throttle Pick-Up Lever

The secondary throttle pickup lever adjustment wraps up the settings which can be made with the carburetor off the car. To check the lever setting, you hold the choke control lever in the open choke position, allowing the throttle pickup lever to drop and then measure the clearance between the pick-up lever and its stop. Bend the outer tang on the fast-idle operating lever to adjust the clearance.

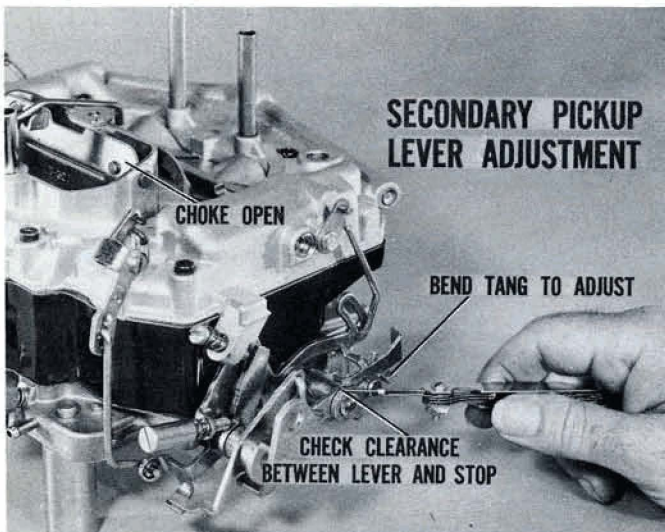

Fig. 30—Lever must clear its stop

### Fast-Idle Speed

Earlier, we set the fast-idle cam and linkage, so now we're ready for the fast-idle speed adjustment, which can be made out of sequence. The engine should be warmed up and the basic ignition timing correctly set before you adjust the fast-idle speed.

#### POSITION SCREW ON CAM

First, with the engine stopped, open the throttle slightly to allow the fast-idle cam to engage the speed adjusting screw. Move the choke valve closed so the speed adjusting screw is positioned on the second step of the cam against the shoulder of the first step.

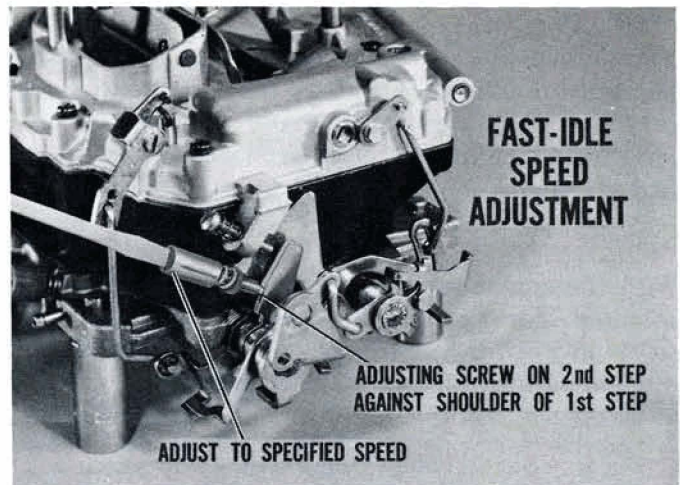

Fig. 31—Warm up engine before adjusting speed

#### RETAIN CAM POSITION

Start the engine without disturbing the position of the speed screw on the fast-idle cam and allow engine speed to settle down. Adjust the screw to get the specified speed and then cycle the fast-idle speed screw on and off the cam to double-check the adjustment.

### Curb-Idle Speed

The next adjustment combines two settings, curb-idle speed and the throttle stop screw, otherwise known as the slow curb-idle speed screw. Since the tie-in between idle speed and mixture adjustments is generally understood, we'll skip the mixture adjustment details here.

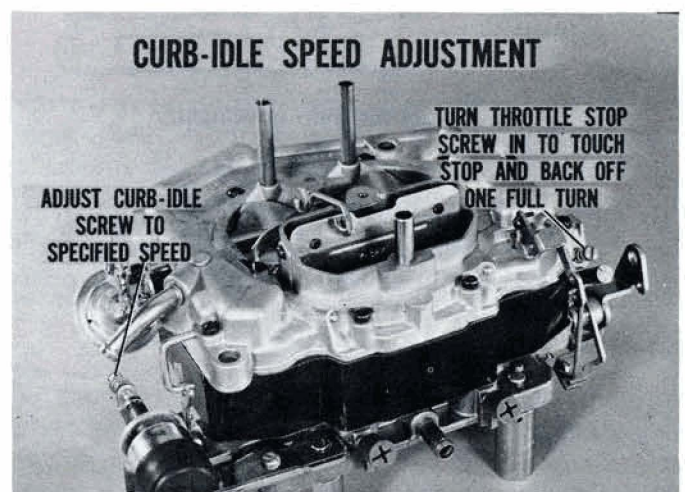

Fig. 32—Set curb-idle speed first

### SOLENOID MUST BE ENERGIZED

You adjust the curb-idle speed with the engine warmed up and running. Snap the throttle to make sure that the curb-idle solenoid core is fully extended and adjust the idle screw to get the specified speed.

### FINISH WITH STOP SETTING

With the engine running at curb-idle speed, and the solenoid core extended, turn the throttle stop screw in until it just touches its stop. Then back it out one full turn to make the final setting.

### Bowl Vent Valve

The final external Thermo-Quad setting is the bowl vent valve adjustment, which must be made after curb-idle speed is set. First, remove the checking hole plug from the bowl cover and set the throttle at the curb-idle position with the curb-idle solenoid core extended.

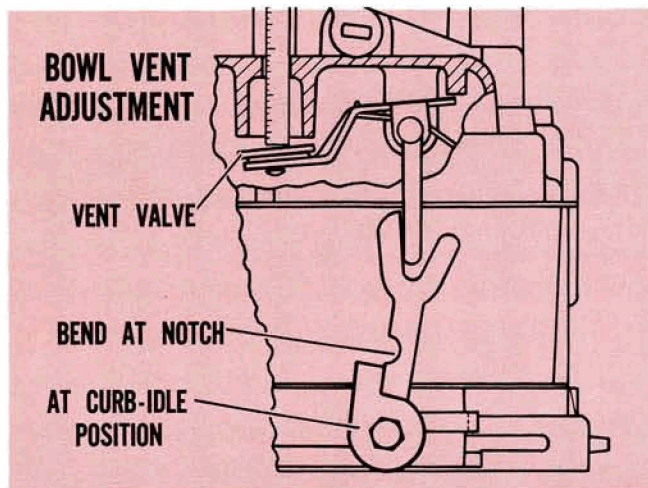

Fig. 33—Contact vent valve lightly

### READ SETTING ON SCALE

To measure the vent valve setting, insert a narrow scale into the checking hole to make light contact with the spring-loaded valve. Bend the vent oper-

ating lever at the notch if adjustment is necessary. After checking the valve opening, install a new plug in the bowl cover checking hole.

### Float Height Setting

Although float height setting is not an external adjustment, it is the only remaining Thermo-Quad adjustment not covered, so we'll describe it here. If the floats are removed, they should be replaced in their original locations. Also, make sure that both floats are free to move up and down without rubbing on the fuel bowl walls.

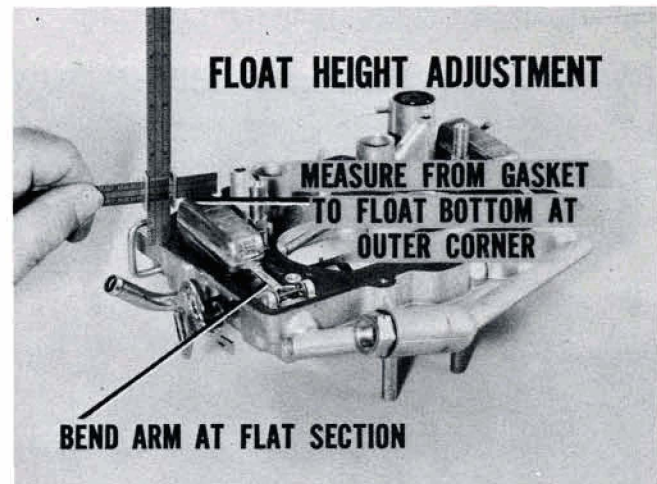

Fig. 34—Measure at outer corner of float

### CHECK VERTICAL DIMENSION

You check float height with the bowl cover inverted so the floats can rest on their needle valves. Make the measurement from the gasket to the bottom surface of the float at the outer corner.

### DO NOT BEND FLOAT LIP

To adjust float height, bend the float lever at the flat section near the lip end. Lift the float when adjusting so the lip on the float lever does not press against the needle valve. If the lip is distorted, the float can hang up.

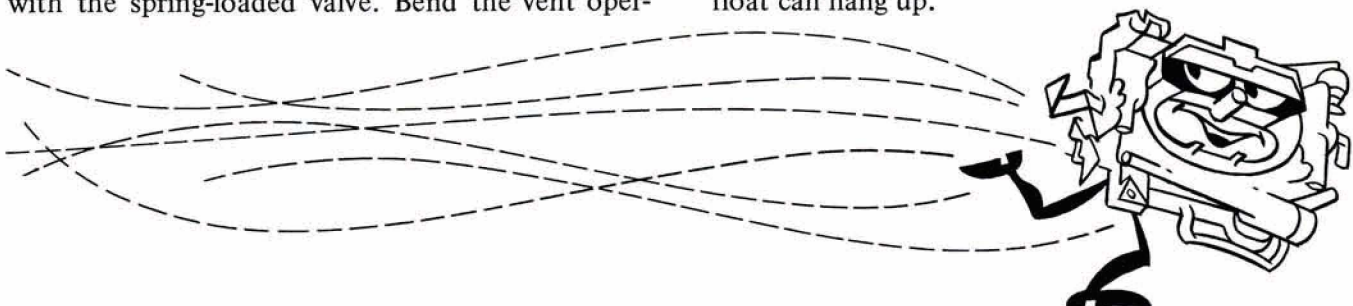



## THERMO-QUAD SERVICING HINTS

To prevent damage, the metering rods should be installed *after* the carburetor sections are assembled. Position the upper rod ends inward in the ends of the step-up piston yoke and carefully install as an assembly to prevent bending the rods or yoke ends.

### CHECK BOTH SEALS

Before you install the bowl cover, make sure the “O”-ring seals are in place in both primary nozzle wells. If either or both seals are left out, fuel will bypass the metering system and cause an over-rich driving mixture.

### MAKE SURE “O” RINGS ARE IN PLACE

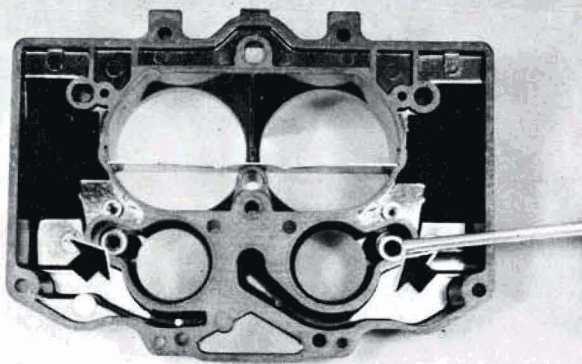

Fig. 35—Omitted ring causes over-rich mixture

### USE THE RIGHT SPRING

The vacuum-kick modulating spring used with carburetors on TorqueFlite models is colored for identification. The manual transmission model spring has a different tension rating and is a plain metal color. Interchanging these springs will upset the basic choke calibration and can cause cold-start stalling. Overstretching the spring can also upset the choke kick operation. The modulating spring can be unhooked accidentally and lost, so keep an eye on it.

### PINS CAN SLIDE OUT

When you install the bowl cover assembly, make sure that the float lever pins are in correct position. If a displaced float pin is trapped between the gasket surfaces when the bowl cover screws are tightened, the bowl wall may crack. Also note that the nozzle well “O”-rings can produce a slight separation between the bowl and bowl cover until they are compressed by tightening the cover screws.

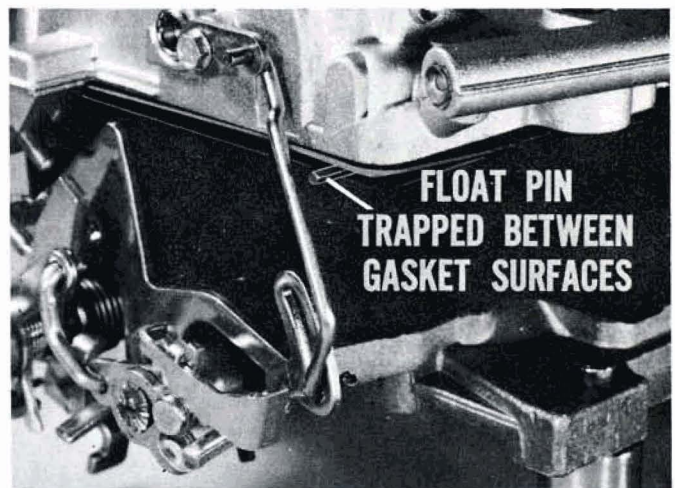

Fig. 36—Float pin can slip out of position

### VALVE SCREWS MUST BE SECURE

If you loosen or remove air, choke, or throttle valve screws, secure them after retightening to prevent them from loosening under vibration and dropping out. Even though these screws are small, they can seriously damage the engine if drawn in. Upset the screw ends with plier pressure or use support so you canpeen the screw ends without bending the shafts.

### HANDLE WITH CARE

Be careful when you remove or install the air cleaner to prevent damage to the vertical vent tubes or the exposed step-up piston yoke. Slight bending or distortion at the yoke ends can result in binding, especially with the piston in the raised position.